

2530GU16

elasto-A-Mounts 25x30
25x30 A UNC1/4-20/16 Shore A

Dimensions:

| | |
|-----------|-----------|
| D | H |
| 0.98 | 1.18 |
| G1 | G2 |
| UNC1/4-20 | UNC1/4-20 |
| L1 | L2 |
| 0.63 | 0.63 |
| Elastomer | ShoreA |
| | 43 |



1. Table of Contents

1. Table of Contents
2. Application Analysis Data
 - 2.1 Calculated Results in Compression and Shear
- Example Application
3. Recommended Compression Load
4. Recommended Shear Load
5. Compression/Injection Molded Standard Product Tolerances
6. Rubber Selection
7. Tightening Torque and Bolt Grades & Class
8. Torque Threaded Stud Test of elasto-A- and B-Mounts
9. Certificate of RoHS compliance and shelf life expectancy.

2530GU16

elasto-A-Mounts 25x30
25x30 A UNC1/4-20/16 Shore A

Dimensions:

| | |
|-----------|-----------|
| D | H |
| 0.98 | 1.18 |
| G1 | G2 |
| UNC1/4-20 | UNC1/4-20 |
| L1 | L2 |
| 0.63 | 0.63 |
| Elastomer | ShoreA |
| | 43 |

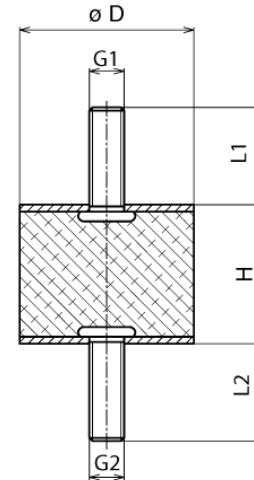

2. Application Analysis Data

Total supported weight:

Mounting Quantity Qty

Force per Mount [N]
 kgf
 lbf
 [kN]

Frequency Source cpm
 Hz

2.1 Calculated Result

Compression:

Deflection 0.000

Spring Rate 42

Natural Frequency ? cpm
 ? Hz

Frequency Ratio ? N/mm²

Calculated Isolation ?

Example Application

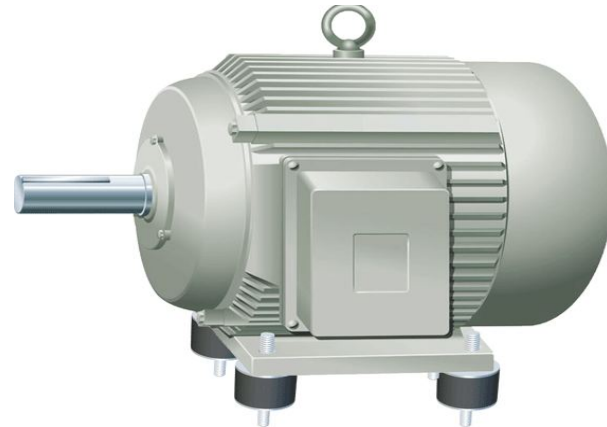

Shear:

Deflection 0.000

Spring Rate 11

Natural frequency ? cpm
 ? Hz

Frequency Ratio ? N/mm²

Isolation ?



2530GU16

elasto-A-Mounts 25x30
25x30 A UNC1/4-20/16 Shore A

Dimensions:

| | |
|-----------|-----------|
| D | H |
| 0.98 | 1.18 |
| G1 | G2 |
| UNC1/4-20 | UNC1/4-20 |
| L1 | L2 |
| 0.63 | 0.63 |
| Elastomer | ShoreA |
| | 43 |

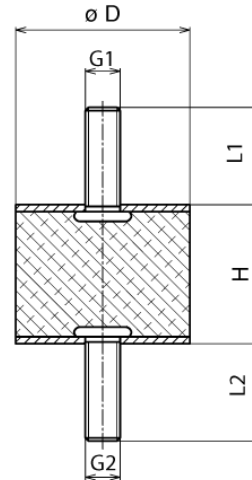

3. Recommended Compression Load

Compression Information

| | |
|----------------|-------|
| Deflection | 0.000 |
| Spring Rate | 42 |
| Maximum Stress | 11.06 |

Compression Deflection Information

0.000
42.0
? Natural Frequency at max. load
? Isolation at

| | |
|----------------------|---------|
| Maximum Force | |
| Maximum Deflection | |
| Stress | 0.00 |
| max. force at 15% | 0.33 |
| Natural Frequency | ? cpm |
| | ? Hz |
| Frequency Ratio | ? N/mm2 |
| Calculated Isolation | ? |

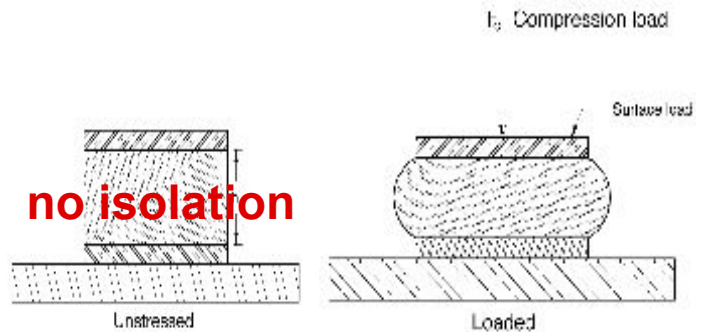

2530GU16

elasto-A-Mounts 25x30
25x30 A UNC1/4-20/16 Shore A

Dimensions:

| | |
|-----------|-----------|
| D | H |
| 0.98 | 1.18 |
| G1 | G2 |
| UNC1/4-20 | UNC1/4-20 |
| L1 | L2 |
| 0.63 | 0.63 |
| Elastomer | ShoreA |
| | 43 |

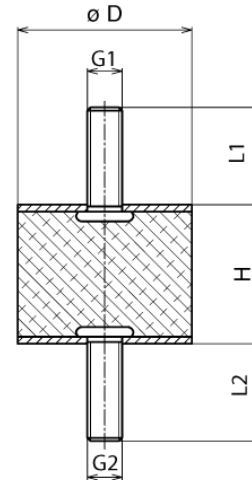

4. Recommended Shear Load

Shear Information

| | |
|-------------|------------------------------------|
| Deflection | <input type="text" value="0.000"/> |
| Spring Rate | <input type="text" value="11"/> |
| max. stress | <input type="text" value="0.08"/> |

Shear Deflection Information

? Natural Frequency by max. load
 ? Isolation by

| | |
|---------------------------|--|
| max. Force | <input type="text"/> |
| max. Deflection | <input type="text"/> |
| Stress | <input type="text" value="0.00"/> |
| max. Shear Stress at 15 % | <input type="text" value="0.09"/> |
| Natural frequency | <input type="text" value="?"/> 1/min |
| | <input type="text" value="?"/> Hz |
| Frequency Ratio | <input type="text" value="?"/> N/mm ² |
| Calculated Isolation | <input type="text" value="?"/> |



2530GU16

elasto-A-Mounts 25x30
25x30 A UNC1/4-20/16 Shore A

Dimensions:

| | |
|-----------|-----------|
| D | H |
| 0.98 | 1.18 |
| G1 | G2 |
| UNC1/4-20 | UNC1/4-20 |
| L1 | L2 |
| 0.63 | 0.63 |
| Elastomer | ShoreA |
| | 43 |

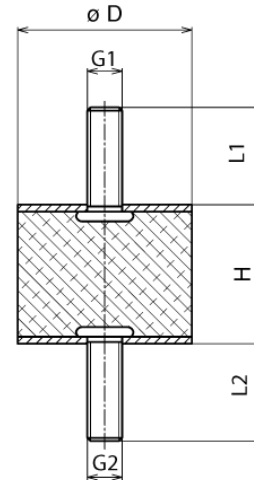

5. Compression/Injection Molded Standard Product Tolerances

Standard compression molded product dimensional tolerances conform to DIN ISO 3302-1 M3 C
Standard Injection molded product tolerances conform to DIN ISO 3302-1 M3 F
Further information regarding product/process quality can be provided upon request.

| Dimensions | | Dimensions | | Tolerance in mm | Tolerance in Inch | Tolerance in mm | Tolerance in Inch |
|------------|-----|------------|-------|-----------------|-------------------|-----------------|-------------------|
| mm | | inch | | Class M3-F | Class M3-F | Class M3-C | Class M3-C |
| from | to | from | to | DIN ISO 3302-1 | DIN ISO 3302-1 | DIN ISO 3302-1 | DIN ISO 3302-1 |
| | | | | mm | inch | mm | inch |
| 0 | 4 | 0 | .15" | ± 0.25 | ± .010 | ± 0.40 | ± .016 |
| 4 | 6.3 | .16" | .25" | ± 0.25 | ± .010 | ± 0.40 | ± .016 |
| 6.3 | 10 | .25" | .39" | ± 0.30 | ± .012 | ± 0.50 | ± .020 |
| 10 | 16 | .39" | .63" | ± 0.40 | ± .016 | ± 0.60 | ± .024 |
| 16 | 25 | .63" | .98" | ± 0.50 | ± .020 | ± 0.80 | ± .032 |
| 25 | 40 | .98" | 1.57" | ± 0.60 | ± .024 | ± 1.00 | ± .040 |
| 40 | 64 | 1.57" | 2.52" | ± 0.80 | ± .032 | ± 1.30 | ± .051 |
| 63 | 100 | 2.38" | 3.94" | ± 1.00 | ± .040 | ± 1.60 | ± .063 |
| 100 | 160 | 3.94" | 6.30" | ± 1.30 | ± .051 | ± 2.00 | ± .079 |
| 160 | - | 6.30" | - | ± 1.3 % | ± 1.3 % | ± 1.3 % | ± 1.3 % |

Standard rubber hardness tolerance ± 5 Shore A Durometer per ASTM D2000

2530GU16

elasto-A-Mounts 25x30
25x30 A UNC1/4-20/16 Shore A

Dimensions:

| | |
|-----------|-----------|
| D | H |
| 0.98 | 1.18 |
| G1 | G2 |
| UNC1/4-20 | UNC1/4-20 |
| L1 | L2 |
| 0.63 | 0.63 |
| Elastomer | ShoreA |
| | 43 |



6. Rubber Selection

| Hardness Range (ShoreA) | Temperature Resistance Range °C (F°) | Short Term Peak Temperature C° (F°) | Tensile Strength (N/mm ²) (PSI) | Tensile Elongation % | Elastomer Basic Material Chemical-Technical Discription Below: (Trade Name) | International Description | PROPERTIES | | | | | | | | | | | | | |
|-------------------------|--------------------------------------|-------------------------------------|---|----------------------|--|---------------------------|------------------|-----------------|---------------------|-------------------|--------------------|------------------|------------------|-----------------|----------------------------------|--------------------|-----------------------------|--------------------------|--------------------------|--|
| | | | | | | | Tensile Strength | Tear Resistance | Abrasion Resistance | Restoring Ability | Rebound Resilience | Ozone Resistance | Flame Resistance | Acid Resistance | Benzene & Mineral Oil Resistance | Gas Impermeability | Water Absorption Resistance | - Temperature Resistance | + Temperature Resistance | |
| 25 - 95 | -40° - 75° (-40° - 167°) | +100° (212°) | 31 (4496) | 800 | Natural Rubber | NR | 2 | 2 | 2 | 2 | 1 | 4 | 5 | 3 | 5 | 4 | 3 | 2 | 4 | |
| 30 - 90 | -30° - 120° (-22° - 248°) | +150° (302°) | 27.5 (3988) | 450 | Chloroprene (Baypren, Neoprene) | CR | 2 | 3 | 2 | 3 | 2 | 2 | 2 | 2 | 3 | 3 | 4 | 4 | 3 | |
| 30 - 90 | -40° - 150° (-40° - 302°) | +180° (356°) | 20 (2901) | 450 | Ethylene-Propylene - Terpolymer | EPDM | 3 | 4 | 3 | 3 | 3 | 1 | 6 | 3 | 5 | 3 | 2 | 3 | 2 | |
| 25 - 95 | -40° - +140° (-40° - 288°) | +160° (320°) | 25 (3626) | 500 | Nitrile Butadiene (Perbunan) | NBR | 3 | 4 | 3 | 3 | 3 | 5 | 5 | 3 | 1 | 3 | 3 | 4 | 3 | |
| 35 - 95 | -30° - +110° (-22° - 230°) | +150° (302°) | 25 (3626) | 450 | Styrene-Butadiene | SBR | 3 | 3 | 2 | 3 | 3 | 5 | 5 | 3 | 5 | 3 | 3 | 3 | 3 | |
| 30 - 85 | -40° - +130° (-40° - 266°) | +150° (302°) | 17 (2466) | 800 | Butyl | IIR | 3 | 2 | 2 | 3 | 5 | 1 | 4 | 4 | 6 | 4 | 2 | 2 | 3 | |
| 55 - 98 | -30° - +80° (-22° - 176°) | +100° (212°) | 30 (4351) | 800 | Polyurethane | PUR | 1 | 2 | 1 | 3 | 3 | 2 | 4 | 5 | 2 | 4 | 5 | 3 | 4 | |
| 40 - 80 | -70° - +180° (-94° - 356°) | +225° (437°) | 8 (1160) | 250 | Silicone Rubber | SI | 5 | 5 | 5 | 5 | 2 | 1 | 4 | 3 | 5 | 5 | 4 | 1 | 1 | |
| 65 - 90 | -30° - +225° (-22° - 437°) | +350° (662°) | 20 (2901) | 400 | Fluorocarbon (Viton) | FPM | 3 | 2 | 5 | 5 | 4 | 1 | 1 | 1 | 1 | 1 | - | 4 | 1 | |

1 = Very Good 2 = Good 3 = Satisfactory 4 = Adequate 5 = Poor 6 = Inadequate

The above mentioned information are used for a guide and can be modified by elastometall to improve certain characteristics.

2530GU16

elasto-A-Mounts 25x30
25x30 A UNC1/4-20/16 Shore A

Dimensions:

| | |
|-----------|-----------|
| D | H |
| 0.98 | 1.18 |
| G1 | G2 |
| UNC1/4-20 | UNC1/4-20 |
| L1 | L2 |
| 0.63 | 0.63 |
| Elastomer | ShoreA |
| | 43 |

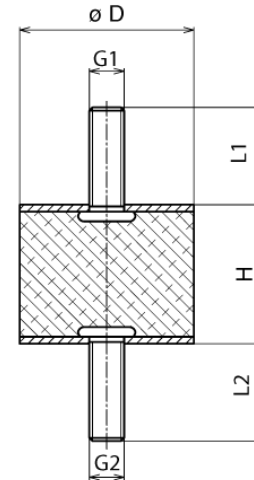

7. Tightening Torque and Bolt Grades & Class

Tightening Torque per ASTM A193 and A194

| Metric Units: (Metric Thread) | | | |
|-------------------------------|------------------------|------------------------|------------------------|
| | CLASS 5.6 | CLASS 8.8 | CLASS 10.9 |
| Thread Size & Pitch | Tightening Torque (Nm) | Tightening Torque (Nm) | Tightening Torque (Nm) |
| M2 | 0.16 | 0.37 | 0.52 |
| M2.3 | 0.26 | 0.6 | 0.84 |
| M2.6 | 0.37 | 0.86 | 1.21 |
| M3 | 0.59 | 1.34 | 1.88 |
| M3.5 | 0.9 | 2.06 | 2.89 |
| M4 | 1.34 | 3.04 | 4.31 |
| M5 | 2.65 | 6.03 | 8.48 |
| M6 | 4.51 | 10.3 | 14.71 |
| M7 | 7.45 | 17.16 | 24.52 |
| M8 | 10.79 | 25.5 | 35.3 |
| M10 | 21.57 | 50.01 | 70.61 |
| M12 | 38.25 | 87.28 | 122.58 |
| M14 | 60.8 | 138.27 | 194.17 |
| M16 | 93.16 | 210.84 | 299.1 |
| M18 | 127.49 | 411.88 | 411.88 |
| M20 | 180.44 | 558.98 | 578.5 |
| M22 | 245.17 | 558.98 | 784.54 |
| M24 | 308.91 | 710.99 | 1000.28 |
| M27 | 460.92 | 1049.32 | 1480.81 |
| M30 | 522.73 | 1421.97 | 2010.38 |

| English Units: (Coarse Thread) | | | |
|--------------------------------|---------------------------|---------------------------|---------------------------|
| | GRADE 2 | GRADE 5 | GRADE 8 |
| Thread Size & Pitch | Tightening Torque (ft-lb) | Tightening Torque (ft-lb) | Tightening Torque (ft-lb) |
| 6-32 | 0.86 | 1.33 | 1.88 |
| 8-32 | 1.58 | 2.44 | 3.44 |
| 10-24 | 2.29 | 3.53 | 4.99 |
| 12-24 | 3.59 | 5.55 | 7.84 |
| 1/4-20 | 5.47 | 8.45 | 11.9 |
| 5/16-18 | 11.3 | 17.4 | 24.6 |
| 3/8-16 | 20 | 30.9 | 43.6 |
| 7/16-14 | 32 | 39.4 | 69.8 |
| 1/2-13 | 48.8 | 75.4 | 106 |
| 9/16-12 | 70.4 | 109 | 154 |
| 5/8-11 | 97.1 | 150 | 212 |
| 3/4-10 | 103 | 366 | 376 |
| 7/8-9 | 167 | 430 | 606 |
| 1-8 | 250 | 561 | 909 |
| 1-1/8-7 | 354 | 794 | 1288 |
| 1-1/4-7 | 500 | 1120 | 1817 |
| 1-3/8-6 | 655 | 1469 | 2382 |
| 1/2-6 | 869 | 1949 | 3161 |

| English Units: (Fine Thread) | | | |
|------------------------------|---------------------------|---------------------------|---------------------------|
| | GRADE 2 | GRADE 5 | GRADE 8 |
| Thread Size & Pitch | Tightening Torque (ft-lb) | Tightening Torque (ft-lb) | Tightening Torque (ft-lb) |
| 6-40 | 0.96 | 1.49 | 2.1 |
| 8-36 | 1.66 | 2.57 | 3.63 |
| 10-32 | 2.61 | 4.04 | 5.7 |
| 12-28 | 3.83 | 5.92 | 8.36 |
| 1/4-28 | 6.26 | 9.7 | 13.7 |
| 5/16-24 | 12.5 | 19.3 | 27.2 |
| 3/8-24 | 22.66 | 35 | 49.4 |
| 7/16-20 | 35.7 | 55.2 | 77.9 |
| 1/2-20 | 55 | 84.9 | 120 |
| 9/16-18 | 78.5 | 121 | 171 |
| 5/8-18 | 110 | 170 | 240 |
| 3/4-16 | 115 | 297 | 420 |
| 7/8-14 | 184 | 473 | 668 |
| 1-12 | 273 | 613 | 995 |
| 1-1/8-12 | 397 | 891 | 1445 |
| 1-1/4-12 | 553 | 1241 | 2012 |
| 1-3/8-12 | 746 | 1673 | 2712 |
| 1-1/2-12 | 978 | 2194 | 3557 |

Non-Standard

2530GU16

elasto-A-Mounts 25x30
25x30 A UNC1/4-20/16 Shore A

Dimensions:

| | |
|-----------|-----------|
| D | H |
| 0.98 | 1.18 |
| G1 | G2 |
| UNC1/4-20 | UNC1/4-20 |
| L1 | L2 |
| 0.63 | 0.63 |
| Elastomer | ShoreA |
| | 43 |

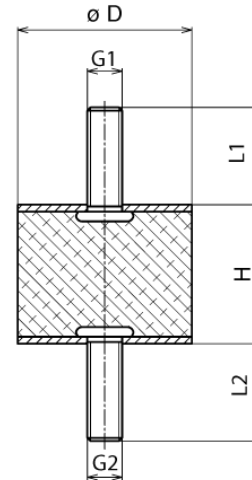

8. Torque Threaded Stud Test of elasto-A- and B-Mounts

Tighten flat bar steel on jaw vise. Setup required torque wrench per table. Use a nut for specimen and tighten it with torque wrench until the required torque is achieved. Loosen nut from specimen and visual check threaded studs for:

- Stud extension
- Thread pitch damaged or sheered
- Connection between washer
- Broken stud

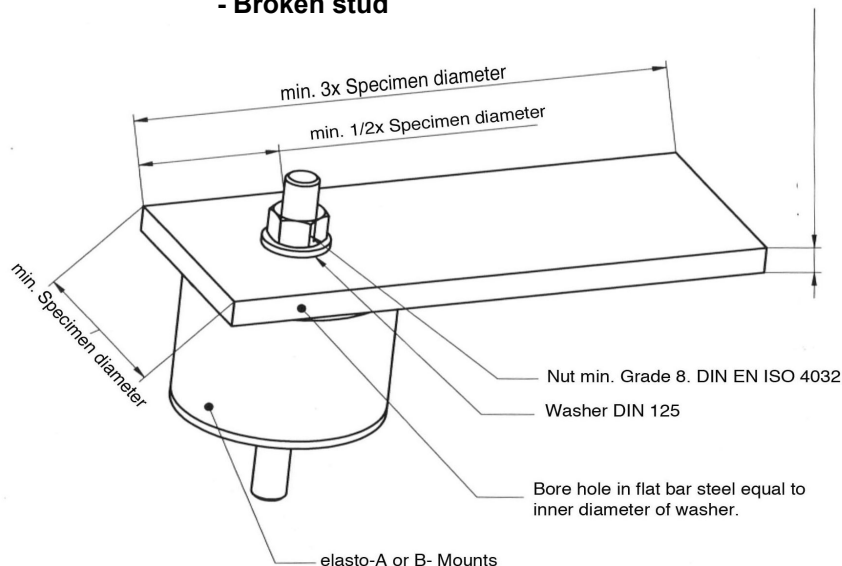



2530GU16

elasto-A-Mounts 25x30
 25x30 A UNC1/4-20/16 Shore A

Dimensions:

| | |
|-----------|-----------|
| D | H |
| 0.98 | 1.18 |
| G1 | G2 |
| UNC1/4-20 | UNC1/4-20 |
| L1 | L2 |
| 0.63 | 0.63 |
| Elastomer | ShoreA |
| | 43 |

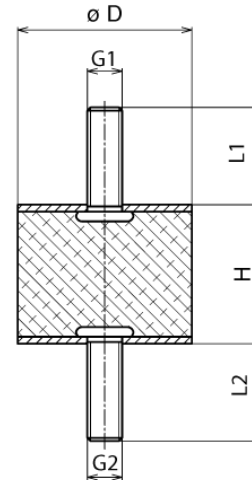

9. Certificate of RoHS Compliance

Customer

We confirm that these mounts are RoHS Compliance.

9. Shelf Life Expectancy

Rubber to metal bonded products have a shelf life expectancy of up to 20 years under certain conditions such as room temperature and avoiding direct sunlight or artificial lights.

- ALWAYS KEEP PARTS AWAY FROM DIRECT SUNLIGHT AND BETWEEN 10° - 30° CELSIUS -