

# 3025BU19

elasto-B-Mounts 30x25  
30x25 B UNC5/16-18/19 Shore A

## Dimensions:

D	H
1.18	0.98
G1	G2
UNC5/16-18	UNC5/16-18
L1	T
0.75	0.31
Elastomer	ShoreA
	57

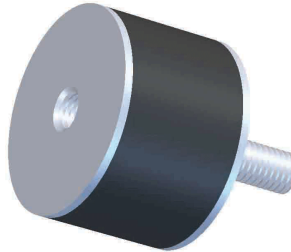

## 1. Table of Contents

1. Table of Contents
2. Application Analysis Data
  - 2.1 Calculated Results in Compression and Shear  
- Example Application
3. Recommended Compression Load
4. Recommended Shear Load
5. Compression/Injection Molded Standard Product Tolerances
6. Rubber Selection
7. Tightening Torque and Bolt Grades & Class
8. Torque Threaded Stud Test of elasto-A- and B-Mounts
9. Certificate of RoHS compliance and shelf life expectancy.

# 3025BU19

elasto-B-Mounts 30x25  
30x25 B UNC5/16-18/19 Shore A

## Dimensions:

D	H
1.18	0.98
G1	G2
UNC5/16-18	UNC5/16-18
L1	T
0.75	0.31
Elastomer	ShoreA
	57



## 2. Application Analysis Data

Total supported weight:

Mounting Quantity  Qty

Force per Mount  [N]  
 kgf  
 lbf  
 [kN]

Frequency Source  cpm  
 Hz

## 2.1 Calculated Result

### Compression:

Deflection  0.000

Spring Rate  437

Natural Frequency  ? cpm  
 ? Hz

Frequency Ratio  ? N/mm<sup>2</sup>

Calculated Isolation  ?

## Example Application



### Shear:

Deflection  0.000

Spring Rate  68

Natural frequency  ? cpm  
 ? Hz

Frequency Ratio  ? N/mm<sup>2</sup>

Isolation  ?

# 3025BU19

elasto-B-Mounts 30x25  
30x25 B UNC5/16-18/19 Shore A

**Dimensions:**

D	H
1.18	0.98
G1	G2
UNC5/16-18	UNC5/16-18
L1	T
0.75	0.31
Elastomer	ShoreA
	57

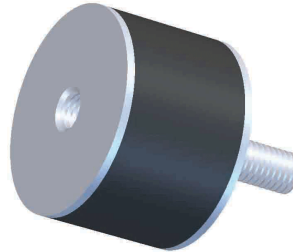

**3. Recommended Compression Load**

**Compression Information**

Deflection	0.000
Spring Rate	437
Maximum Stress	41.99

**Compression Deflection Information**

0.000
437.5
? Natural Frequency at max. load
? Isolation at

Maximum Force	
Maximum Deflection	
Stress	0.00
max. force at 15%	1.02
Natural Frequency	? cpm
	? Hz
Frequency Ratio	? N/mm <sup>2</sup>
Calculated Isolation	?

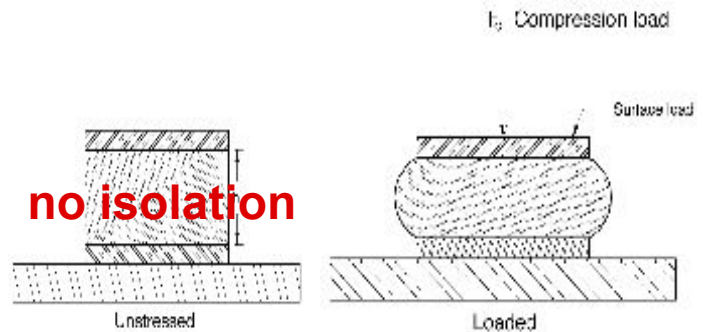

# 3025BU19

elasto-B-Mounts 30x25  
30x25 B UNC5/16-18/19 Shore A

**Dimensions:**

D	H
1.18	0.98
G1	G2
UNC5/16-18	UNC5/16-18
L1	T
0.75	0.31
Elastomer	ShoreA
	57

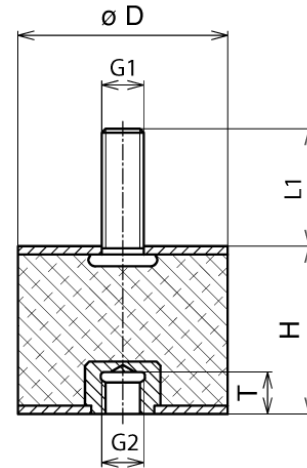

**4. Recommended Shear Load**

**Shear Information**

Deflection	0.000
Spring Rate	68
max. stress	0.12

**Shear Deflection Information**

0.000
67.9
? Natural Frequency by max. load
? Isolation by

max. Force	
max. Deflection	
Stress	0.00
max. Shear Stress at 15 %	0.16
Natural frequency	? 1/min
	? Hz
Frequency Ratio	? N/mm2
Calculated Isolation	?

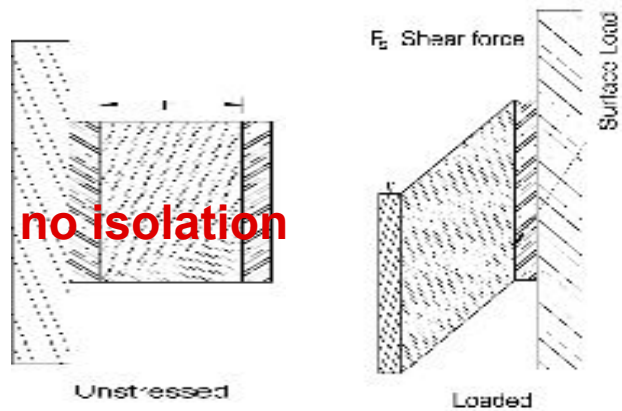

# 3025BU19

elasto-B-Mounts 30x25  
30x25 B UNC5/16-18/19 Shore A

**Dimensions:**

D	H
1.18	0.98
G1	G2
UNC5/16-18	UNC5/16-18
L1	T
0.75	0.31
Elastomer	ShoreA
	57

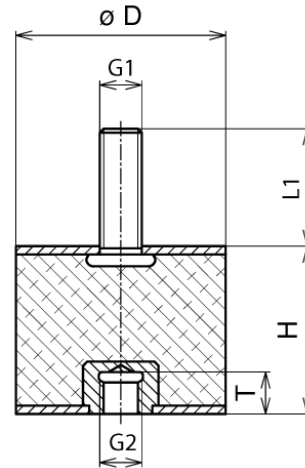
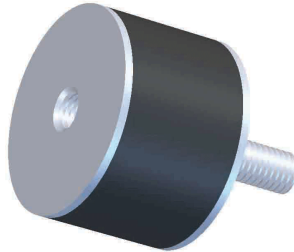

**5. Compression/Injection Molded Standard Product Tolerances**

Standard compression molded product dimensional tolerances conform to DIN ISO 3302-1 M3 C  
Standard Injection molded product tolerances conform to DIN ISO 3302-1 M3 F  
Further information regarding product/process quality can be provided upon request.

Dimensions		Dimensions		Tolerance in mm	Tolerance in Inch	Tolerance in mm	Tolerance in Inch
mm		inch		Class M3-F	Class M3-F	Class M3-C	Class M3-C
from	to	from	to	DIN ISO 3302-1	DIN ISO 3302-1	DIN ISO 3302-1	DIN ISO 3302-1
				mm	inch	mm	inch
0	4	0	.15"	± 0.25	± .010	± 0.40	± .016
4	6.3	.16"	.25"	± 0.25	± .010	± 0.40	± .016
6.3	10	.25"	.39"	± 0.30	± .012	± 0.50	± .020
10	16	.39"	.63"	± 0.40	± .016	± 0.60	± .024
16	25	.63"	.98"	± 0.50	± .020	± 0.80	± .032
25	40	.98"	1.57"	± 0.60	± .024	± 1.00	± .040
40	64	1.57"	2.52"	± 0.80	± .032	± 1.30	± .051
63	100	2.38"	3.94"	± 1.00	± .040	± 1.60	± .063
100	160	3.94"	6.30"	± 1.30	± .051	± 2.00	± .079
160	-	6.30"	-	± 1.3 %	± 1.3 %	± 1.3 %	± 1.3 %

Standard rubber hardness tolerance ± 5 Shore A Durometer per ASTM D2000

# 3025BU19

elasto-B-Mounts 30x25  
30x25 B UNC5/16-18/19 Shore A

**Dimensions:**

D	H
1.18	0.98
G1	G2
UNC5/16-18	UNC5/16-18
L1	T
0.75	0.31
Elastomer	ShoreA
	57



## 6. Rubber Selection

Hardness Range (ShoreA)	Temperature Resistance Range °C (F°)	Short Term Peak Temperature C° (F°)	Tensile Strength (N/mm <sup>2</sup> ) (PSI)	Tensile Elongation %	Elastomer Basic Material  Chemical-Technical Discription  Below: (Trade Name)	International Description	PROPERTIES													
							Tensile Strength	Tear Resistance	Abrasion Resistance	Restoring Ability	Rebound Resilience	Ozone Resistance	Flame Resistance	Acid Resistance	Benzene & Mineral Oil Resistance	Gas Impermeability	Water Absorption Resistance	- Temperature Resistance	+ Temperature Resistance	
25 - 95	<b>-40° - 75°</b> (-40° - 167°)	<b>+100°</b> (212°)	<b>31</b> (4496)	800	Natural Rubber	NR	2	2	2	2	1	4	5	3	5	4	3	2	4	
30 - 90	<b>-30° - 120°</b> (-22° - 248°)	<b>+150°</b> (302°)	<b>27.5</b> (3988)	450	Chloroprene (Baypren, Neoprene)	CR	2	3	2	3	2	2	2	2	3	3	4	4	3	
30 - 90	<b>-40° - 150°</b> (-40° - 302°)	<b>+180°</b> (356°)	<b>20</b> (2901)	450	Ethylene-Propylene - Terpolymer	EPDM	3	4	3	3	3	1	6	3	5	3	2	3	2	
25 - 95	<b>-40° - +140°</b> (-40° - 288°)	<b>+160°</b> (320°)	<b>25</b> (3626)	500	Nitrile Butadiene (Perbunan)	NBR	3	4	3	3	3	5	5	3	1	3	3	4	3	
35 - 95	<b>-30° - +110°</b> (-22° - 230°)	<b>+150°</b> (302°)	<b>25</b> (3626)	450	Styrene-Butadiene	SBR	3	3	2	3	3	5	5	3	5	3	3	3	3	
30 - 85	<b>-40° - +130°</b> (-40° - 266°)	<b>+150°</b> (302°)	<b>17</b> (2466)	800	Butyl	IIR	3	2	2	3	5	1	4	4	6	4	2	2	3	
55 - 98	<b>-30° - +80°</b> (-22° - 176°)	<b>+100°</b> (212°)	<b>30</b> (4351)	800	Polyurethane	PUR	1	2	1	3	3	2	4	5	2	4	5	3	4	
40 - 80	<b>-70° - +180°</b> (-94° - 356°)	<b>+225°</b> (437°)	<b>8</b> (1160)	250	Silicone Rubber	SI	5	5	5	5	2	1	4	3	5	5	4	1	1	
65 - 90	<b>-30° - +225°</b> (-22° - 437°)	<b>+350°</b> (662°)	<b>20</b> (2901)	400	Fluorocarbon (Viton)	FPM	3	2	5	5	4	1	1	1	1	1	-	4	1	

1 = Very Good    2 = Good    3 = Satisfactory    4 = Adequate    5 = Poor    6 = Inadequate

The above mentioned information are used for a guide and can be modified by elastometall to improve certain characteristics.



# 3025BU19

elasto-B-Mounts 30x25  
30x25 B UNC5/16-18/19 Shore A

**Dimensions:**

D	H
1.18	0.98
G1	G2
UNC5/16-18	UNC5/16-18
L1	T
0.75	0.31
Elastomer	ShoreA
	57

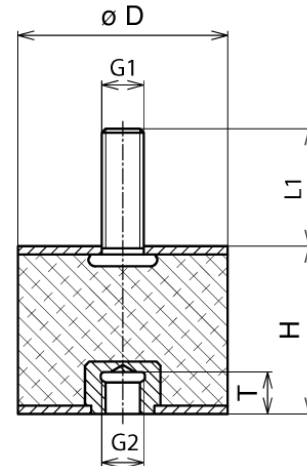

## 7. Tightening Torque and Bolt Grades & Class

Tightening Torque per ASTM A193 and A194

Metric Units: (Metric Thread)			
	CLASS 5.6	CLASS 8.8	CLASS 10.9
Thread Size & Pitch	Tightening Torque (Nm)	Tightening Torque (Nm)	Tightening Torque (Nm)
M2	0.16	0.37	0.52
M2.3	0.26	0.6	0.84
M2.6	0.37	0.86	1.21
M3	0.59	1.34	1.88
M3.5	0.9	2.06	2.89
M4	1.34	3.04	4.31
M5	2.65	6.03	8.48
M6	4.51	10.3	14.71
M7	7.45	17.16	24.52
M8	10.79	25.5	35.3
M10	21.57	50.01	70.61
M12	38.25	87.28	122.58
M14	60.8	138.27	194.17
M16	93.16	210.84	299.1
M18	127.49	411.88	411.88
M20	180.44	558.98	578.5
M22	245.17	558.98	784.54
M24	308.91	710.99	1000.28
M27	460.92	1049.32	1480.81
M30	522.73	1421.97	2010.38

English Units: (Coarse Thread)			
	GRADE 2	GRADE 5	GRADE 8
Thread Size & Pitch	Tightening Torque (ft-lb)	Tightening Torque (ft-lb)	Tightening Torque (ft-lb)
6-32	0.86	1.33	1.88
8-32	1.58	2.44	3.44
10-24	2.29	3.53	4.99
12-24	3.59	5.55	7.84
1/4-20	5.47	8.45	11.9
5/16-18	11.3	17.4	24.6
3/8-16	20	30.9	43.6
7/16-14	32	39.4	69.8
1/2-13	48.8	75.4	106
9/16-12	70.4	109	154
5/8-11	97.1	150	212
3/4-10	103	366	376
7/8-9	167	430	606
1-8	250	561	909
1-1/8-7	354	794	1288
1-1/4-7	500	1120	1817
1-3/8-6	655	1469	2382
1/2-6	869	1949	3161

English Units: (Fine Thread)			
	GRADE 2	GRADE 5	GRADE 8
Thread Size & Pitch	Tightening Torque (ft-lb)	Tightening Torque (ft-lb)	Tightening Torque (ft-lb)
6-40	0.96	1.49	2.1
8-36	1.66	2.57	3.63
10-32	2.61	4.04	5.7
12-28	3.83	5.92	8.36
1/4-28	6.26	9.7	13.7
5/16-24	12.5	19.3	27.2
3/8-24	22.66	35	49.4
7/16-20	35.7	55.2	77.9
1/2-20	55	84.9	120
9/16-18	78.5	121	171
5/8-18	110	170	240
3/4-16	115	297	420
7/8-14	184	473	668
1-12	273	613	995
1-1/8-12	397	891	1445
1-1/4-12	553	1241	2012
1-3/8-12	746	1673	2712
1-1/2-12	978	2194	3557

Non-Standard

# 3025BU19

elasto-B-Mounts 30x25  
30x25 B UNC5/16-18/19 Shore A

## Dimensions:

D	H
1.18	0.98
G1	G2
UNC5/16-18	UNC5/16-18
L1	T
0.75	0.31
Elastomer	ShoreA
	57



## 8. Torque Threaded Stud Test of elasto-A- and B-Mounts

Tighten flat bar steel on jaw vise. Setup required torque wrench per table. Use a nut for specimen and tighten it with torque wrench until the required torque is achieved. Loosen nut from specimen and visual check threaded studs for:

- Stud extension
- Thread pitch damaged or sheered
- Connection between washer
- Broken stud







# 3025BU19

elasto-B-Mounts 30x25  
 30x25 B UNC5/16-18/19 Shore A

**Dimensions:**

D	H
1.18	0.98
G1	G2
UNC5/16-18	UNC5/16-18
L1	T
0.75	0.31
Elastomer	ShoreA
	57

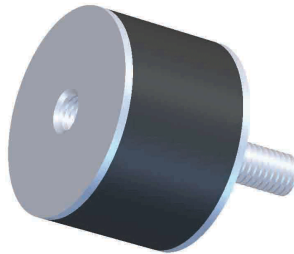

9. Certificate of RoHS Compliance

Customer

We confirm that these mounts are RoHS Compliance.

9. Shelf Life Expectancy

Rubber to metal bonded products have a shelf life expectancy of up to 20 years under certain conditions such as room temperature and avoiding direct sunlight or artificial lights.

**- ALWAYS KEEP PARTS AWAY FROM DIRECT SUNLIGHT AND BETWEEN 10° - 30° CELSIUS -**