

# 3838A10U25

elasto-A-Mounts 38x38

38x38 A UNC3/8-16/25 Shore A

## Dimensions:

|           |           |
|-----------|-----------|
| D         | H         |
| 1.50      | 1.50      |
| G1        | G2        |
| UNC3/8-16 | UNC3/8-16 |
| L1        | L2        |
| 0.98      | 0.98      |
| Elastomer | ShoreA    |
|           | 57        |

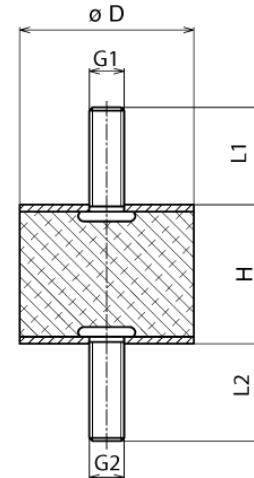

## 1. Table of Contents

1. Table of Contents
2. Application Analysis Data
  - 2.1 Calculated Results in Compression and Shear  
- Example Application
3. Recommended Compression Load
4. Recommended Shear Load
5. Compression/Injection Molded Standard Product Tolerances
6. Rubber Selection
7. Tightening Torque and Bolt Grades & Class
8. Torque Threaded Stud Test of elasto-A- and B-Mounts
9. Certificate of RoHS compliance and shelf life expectancy.

# 3838A10U25

elasto-A-Mounts 38x38  
38x38 A UNC3/8-16/25 Shore A

## Dimensions:

|           |           |
|-----------|-----------|
| D         | H         |
| 1.50      | 1.50      |
| G1        | G2        |
| UNC3/8-16 | UNC3/8-16 |
| L1        | L2        |
| 0.98      | 0.98      |
| Elastomer | ShoreA    |
|           | 57        |



## 2. Application Analysis Data

Total supported weight:

Mounting Quantity  Qty

Force per Mount  [N]  
 kgf  
 lbf  
 [kN]

Frequency Source  cpm  
 Hz

## 2.1 Calculated Result

### Compression:

Deflection  0.000

Spring Rate  144

Natural Frequency  ? cpm  
 ? Hz

Frequency Ratio  ? N/mm<sup>2</sup>

Calculated Isolation  ?

## Example Application



### Shear:

Deflection  0.000

Spring Rate  35

Natural frequency  ? cpm  
 ? Hz

Frequency Ratio  ? N/mm<sup>2</sup>

Isolation  ?



elastometall Ky LLC •  
+1 (502) 871-4422  
www.elastometall.com

Product Specification/  
Certificates and  
Assembly Instruction

elasto 250113  
Release: 1  
Page: 3 of 8

# 3838A10U25

elasto-A-Mounts 38x38  
38x38 A UNC3/8-16/25 Shore A

### Dimensions:

|           |           |
|-----------|-----------|
| D         | H         |
| 1.50      | 1.50      |
| G1        | G2        |
| UNC3/8-16 | UNC3/8-16 |
| L1        | L2        |
| 0.98      | 0.98      |
| Elastomer | ShoreA    |
|           | 57        |



### 3. Recommended Compression Load

#### Compression Information

|                |       |
|----------------|-------|
| Deflection     | 0.000 |
| Spring Rate    | 144   |
| Maximum Stress | 19.44 |

#### Compression Deflection Information

0.000  
143.6  
? Natural Frequency at max. load  
? Isolation at

|                      |                     |
|----------------------|---------------------|
| Maximum Force        |                     |
| Maximum Deflection   |                     |
| Stress               | 0.00                |
| max. force at 15%    | 0.65                |
| Natural Frequency    | ? cpm               |
|                      | ? Hz                |
| Frequency Ratio      | ? N/mm <sup>2</sup> |
| Calculated Isolation | ?                   |

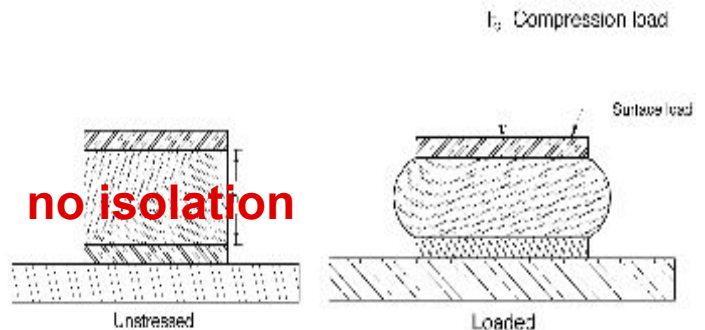



# 3838A10U25

elasto-A-Mounts 38x38  
38x38 A UNC3/8-16/25 Shore A

**Dimensions:**

|           |           |
|-----------|-----------|
| D         | H         |
| 1.50      | 1.50      |
| G1        | G2        |
| UNC3/8-16 | UNC3/8-16 |
| L1        | L2        |
| 0.98      | 0.98      |
| Elastomer | ShoreA    |
|           | 57        |

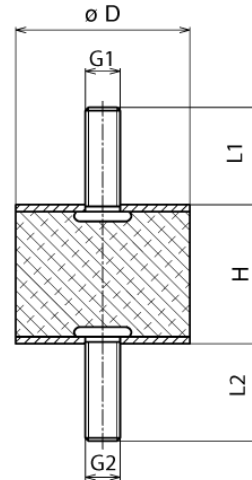

**4. Recommended Shear Load**

**Shear Information**

|             |       |
|-------------|-------|
| Deflection  | 0.000 |
| Spring Rate | 35    |
| max. stress | 0.38  |

**Shear Deflection Information**

|                                  |
|----------------------------------|
| 0.000                            |
| 35.3                             |
| ? Natural Frequency by max. load |
| ? Isolation by                   |

|                           |         |
|---------------------------|---------|
| max. Force                |         |
| max. Deflection           |         |
| Stress                    | 0.00    |
| max. Shear Stress at 15 % | 0.16    |
| Natural frequency         | ? 1/min |
|                           | ? Hz    |
| Frequency Ratio           | ? N/mm2 |
| Calculated Isolation      | ?       |

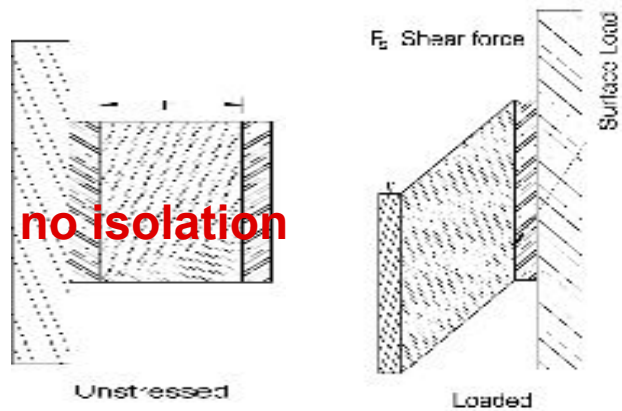

# 3838A10U25

elasto-A-Mounts 38x38  
38x38 A UNC3/8-16/25 Shore A

**Dimensions:**

|           |           |
|-----------|-----------|
| D         | H         |
| 1.50      | 1.50      |
| G1        | G2        |
| UNC3/8-16 | UNC3/8-16 |
| L1        | L2        |
| 0.98      | 0.98      |
| Elastomer | ShoreA    |
|           | 57        |



## 5. Compression/Injection Molded Standard Product Tolerances

Standard compression molded product dimensional tolerances conform to DIN ISO 3302-1 M3 C  
Standard Injection molded product tolerances conform to DIN ISO 3302-1 M3 F  
Further information regarding product/process quality can be provided upon request.

| Dimensions |     | Dimensions |       | Tolerance in mm | Tolerance in Inch | Tolerance in mm | Tolerance in Inch |
|------------|-----|------------|-------|-----------------|-------------------|-----------------|-------------------|
| mm         |     | inch       |       | Class M3-F      | Class M3-F        | Class M3-C      | Class M3-C        |
| from       | to  | from       | to    | DIN ISO 3302-1  | DIN ISO 3302-1    | DIN ISO 3302-1  | DIN ISO 3302-1    |
|            |     |            |       | mm              | inch              | mm              | inch              |
| 0          | 4   | 0          | .15"  | ± 0.25          | ± .010            | ± 0.40          | ± .016            |
| 4          | 6.3 | .16"       | .25"  | ± 0.25          | ± .010            | ± 0.40          | ± .016            |
| 6.3        | 10  | .25"       | .39"  | ± 0.30          | ± .012            | ± 0.50          | ± .020            |
| 10         | 16  | .39"       | .63"  | ± 0.40          | ± .016            | ± 0.60          | ± .024            |
| 16         | 25  | .63"       | .98"  | ± 0.50          | ± .020            | ± 0.80          | ± .032            |
| 25         | 40  | .98"       | 1.57" | ± 0.60          | ± .024            | ± 1.00          | ± .040            |
| 40         | 64  | 1.57"      | 2.52" | ± 0.80          | ± .032            | ± 1.30          | ± .051            |
| 63         | 100 | 2.38"      | 3.94" | ± 1.00          | ± .040            | ± 1.60          | ± .063            |
| 100        | 160 | 3.94"      | 6.30" | ± 1.30          | ± .051            | ± 2.00          | ± .079            |
| 160        | -   | 6.30"      | -     | ± 1.3 %         | ± 1.3 %           | ± 1.3 %         | ± 1.3 %           |

Standard rubber hardness tolerance ± 5 Shore A Durometer per ASTM D2000

# 3838A10U25

elasto-A-Mounts 38x38  
38x38 A UNC3/8-16/25 Shore A

**Dimensions:**

|           |           |
|-----------|-----------|
| D         | H         |
| 1.50      | 1.50      |
| G1        | G2        |
| UNC3/8-16 | UNC3/8-16 |
| L1        | L2        |
| 0.98      | 0.98      |
| Elastomer | ShoreA    |
| 57        |           |

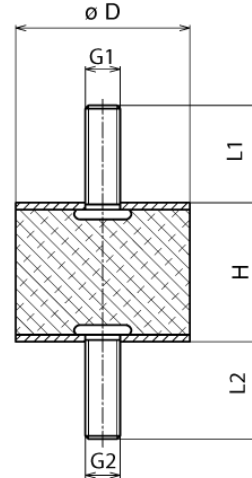

## 6. Rubber Selection

| Hardness Range (ShoreA) | Temperature Resistance Range °C (F°) | Short Term Peak Temperature C° (F°) | Tensile Strength (N/mm <sup>2</sup> ) (PSI) | Tensile Elongation % | Elastomer Basic Material<br><br>Chemical-Technical Discription<br><br>Below:<br>(Trade Name) | International Description | PROPERTIES       |                 |                     |                   |                    |                  |                  |                 |                                  |                    |                             |                          |                          |  |
|-------------------------|--------------------------------------|-------------------------------------|---|----------------------|--|---------------------------|------------------|-----------------|---------------------|-------------------|--------------------|------------------|------------------|-----------------|----------------------------------|--------------------|-----------------------------|--------------------------|--------------------------|--|
|                         |                                      |                                     |   |                      |  |                           | Tensile Strength | Tear Resistance | Abrasion Resistance | Restoring Ability | Rebound Resilience | Ozone Resistance | Flame Resistance | Acid Resistance | Benzene & Mineral Oil Resistance | Gas Impermeability | Water Absorption Resistance | - Temperature Resistance | + Temperature Resistance |  |
| 25 - 95                 | -40° - 75°<br>(-40° - 167°)          | +100°<br>(212°)                     | 31<br>(4496)                                | 800                  | Natural Rubber   | NR                        | 2                | 2               | 2                   | 2                 | 1                  | 4                | 5                | 3               | 5                                | 4                  | 3                           | 2                        | 4                        |  |
| 30 - 90                 | -30° - 120°<br>(-22° - 248°)         | +150°<br>(302°)                     | 27.5<br>(3988)                              | 450                  | Chloroprene<br>(Baypren, Neoprene)   | CR                        | 2                | 3               | 2                   | 3                 | 2                  | 2                | 2                | 2               | 3                                | 3                  | 4                           | 4                        | 3                        |  |
| 30 - 90                 | -40° - 150°<br>(-40° - 302°)         | +180°<br>(356°)                     | 20<br>(2901)                                | 450                  | Ethylene-Propylene -<br>Terpolymer   | EPDM                      | 3                | 4               | 3                   | 3                 | 3                  | 1                | 6                | 3               | 5                                | 3                  | 2                           | 3                        | 2                        |  |
| 25 - 95                 | -40° - 140°<br>(-40° - 288°)         | +160°<br>(320°)                     | 25<br>(3626)                                | 500                  | Nitrile Butadiene<br>(Perbunan)  | NBR                       | 3                | 4               | 3                   | 3                 | 3                  | 5                | 5                | 3               | 1                                | 3                  | 3                           | 4                        | 3                        |  |
| 35 - 95                 | -30° - 110°<br>(-22° - 230°)         | +150°<br>(302°)                     | 25<br>(3626)                                | 450                  | Styrene-Butadiene  | SBR                       | 3                | 3               | 2                   | 3                 | 3                  | 5                | 5                | 3               | 5                                | 3                  | 3                           | 3                        | 3                        |  |
| 30 - 85                 | -40° - 130°<br>(-40° - 266°)         | +150°<br>(302°)                     | 17<br>(2466)                                | 800                  | Butyl  | IIR                       | 3                | 2               | 2                   | 3                 | 5                  | 1                | 4                | 4               | 6                                | 4                  | 2                           | 2                        | 3                        |  |
| 55 - 98                 | -30° - 80°<br>(-22° - 176°)          | +100°<br>(212°)                     | 30<br>(4351)                                | 800                  | Polyurethane   | PUR                       | 1                | 2               | 1                   | 3                 | 3                  | 2                | 4                | 5               | 2                                | 4                  | 5                           | 3                        | 4                        |  |
| 40 - 80                 | -70° - 180°<br>(-94° - 356°)         | +225°<br>(437°)                     | 8<br>(1160)                                 | 250                  | Silicone Rubber  | SI                        | 5                | 5               | 5                   | 5                 | 2                  | 1                | 4                | 3               | 5                                | 5                  | 4                           | 1                        | 1                        |  |
| 65 - 90                 | -30° - 225°<br>(-22° - 437°)         | +350°<br>(662°)                     | 20<br>(2901)                                | 400                  | Fluorocarbon (Viton)   | FPM                       | 3                | 2               | 5                   | 5                 | 4                  | 1                | 1                | 1               | 1                                | 1                  | -                           | 4                        | 1                        |  |

1 = Very Good    2 = Good    3 = Satisfactory    4 = Adequate    5 = Poor    6 = Inadequate

The above mentioned information are used for a guide and can be modified by elastometall to improve certain characteristics.





# 3838A10U25

elasto-A-Mounts 38x38  
38x38 A UNC3/8-16/25 Shore A

**Dimensions:**

|           |           |
|-----------|-----------|
| D         | H         |
| 1.50      | 1.50      |
| G1        | G2        |
| UNC3/8-16 | UNC3/8-16 |
| L1        | L2        |
| 0.98      | 0.98      |
| Elastomer | ShoreA    |
|           | 57        |

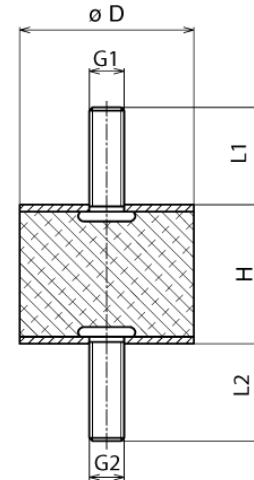

## 7. Tightening Torque and Bolt Grades & Class

Tightening Torque per ASTM A193 and A194

| Metric Units: (Metric Thread) |                        |                        |                        |
|-------------------------------|------------------------|------------------------|------------------------|
|                               | CLASS 5.6              | CLASS 8.8              | CLASS 10.9             |
| Thread Size & Pitch           | Tightening Torque (Nm) | Tightening Torque (Nm) | Tightening Torque (Nm) |
| M2                            | 0.16                   | 0.37                   | 0.52                   |
| M2.3                          | 0.26                   | 0.6                    | 0.84                   |
| M2.6                          | 0.37                   | 0.86                   | 1.21                   |
| M3                            | 0.59                   | 1.34                   | 1.88                   |
| M3.5                          | 0.9                    | 2.06                   | 2.89                   |
| M4                            | 1.34                   | 3.04                   | 4.31                   |
| M5                            | 2.65                   | 6.03                   | 8.48                   |
| M6                            | 4.51                   | 10.3                   | 14.71                  |
| M7                            | 7.45                   | 17.16                  | 24.52                  |
| M8                            | 10.79                  | 25.5                   | 35.3                   |
| M10                           | 21.57                  | 50.01                  | 70.61                  |
| M12                           | 38.25                  | 87.28                  | 122.58                 |
| M14                           | 60.8                   | 138.27                 | 194.17                 |
| M16                           | 93.16                  | 210.84                 | 299.1                  |
| M18                           | 127.49                 | 411.88                 | 411.88                 |
| M20                           | 180.44                 | 558.98                 | 578.5                  |
| M22                           | 245.17                 | 558.98                 | 784.54                 |
| M24                           | 308.91                 | 710.99                 | 1000.28                |
| M27                           | 460.92                 | 1049.32                | 1480.81                |
| M30                           | 522.73                 | 1421.97                | 2010.38                |

| English Units: (Coarse Thread) |                           |                           |                           |
|--------------------------------|---------------------------|---------------------------|---------------------------|
|                                | GRADE 2                   | GRADE 5                   | GRADE 8                   |
| Thread Size & Pitch            | Tightening Torque (ft-lb) | Tightening Torque (ft-lb) | Tightening Torque (ft-lb) |
| 6-32                           | 0.86                      | 1.33                      | 1.88                      |
| 8-32                           | 1.58                      | 2.44                      | 3.44                      |
| 10-24                          | 2.29                      | 3.53                      | 4.99                      |
| 12-24                          | 3.59                      | 5.55                      | 7.84                      |
| 1/4-20                         | 5.47                      | 8.45                      | 11.9                      |
| 5/16-18                        | 11.3                      | 17.4                      | 24.6                      |
| 3/8-16                         | 20                        | 30.9                      | 43.6                      |
| 7/16-14                        | 32                        | 39.4                      | 69.8                      |
| 1/2-13                         | 48.8                      | 75.4                      | 106                       |
| 9/16-12                        | 70.4                      | 109                       | 154                       |
| 5/8-11                         | 97.1                      | 150                       | 212                       |
| 3/4-10                         | 103                       | 366                       | 376                       |
| 7/8-9                          | 167                       | 430                       | 606                       |
| 1-8                            | 250                       | 561                       | 909                       |
| 1-1/8-7                        | 354                       | 794                       | 1288                      |
| 1-1/4-7                        | 500                       | 1120                      | 1817                      |
| 1-3/8-6                        | 655                       | 1469                      | 2382                      |
| 1/2-6                          | 869                       | 1949                      | 3161                      |

| English Units: (Fine Thread) |                           |                           |                           |
|------------------------------|---------------------------|---------------------------|---------------------------|
|                              | GRADE 2                   | GRADE 5                   | GRADE 8                   |
| Thread Size & Pitch          | Tightening Torque (ft-lb) | Tightening Torque (ft-lb) | Tightening Torque (ft-lb) |
| 6-40                         | 0.96                      | 1.49                      | 2.1                       |
| 8-36                         | 1.66                      | 2.57                      | 3.63                      |
| 10-32                        | 2.61                      | 4.04                      | 5.7                       |
| 12-28                        | 3.83                      | 5.92                      | 8.36                      |
| 1/4-28                       | 6.26                      | 9.7                       | 13.7                      |
| 5/16-24                      | 12.5                      | 19.3                      | 27.2                      |
| 3/8-24                       | 22.66                     | 35                        | 49.4                      |
| 7/16-20                      | 35.7                      | 55.2                      | 77.9                      |
| 1/2-20                       | 55                        | 84.9                      | 120                       |
| 9/16-18                      | 78.5                      | 121                       | 171                       |
| 5/8-18                       | 110                       | 170                       | 240                       |
| 3/4-16                       | 115                       | 297                       | 420                       |
| 7/8-14                       | 184                       | 473                       | 668                       |
| 1-12                         | 273                       | 613                       | 995                       |
| 1-1/8-12                     | 397                       | 891                       | 1445                      |
| 1-1/4-12                     | 553                       | 1241                      | 2012                      |
| 1-3/8-12                     | 746                       | 1673                      | 2712                      |
| 1-1/2-12                     | 978                       | 2194                      | 3557                      |

Non-Standard

# 3838A10U25

elasto-A-Mounts 38x38

38x38 A UNC3/8-16/25 Shore A

## Dimensions:

|           |           |
|-----------|-----------|
| D         | H         |
| 1.50      | 1.50      |
| G1        | G2        |
| UNC3/8-16 | UNC3/8-16 |
| L1        | L2        |
| 0.98      | 0.98      |
| Elastomer | ShoreA    |
|           | 57        |

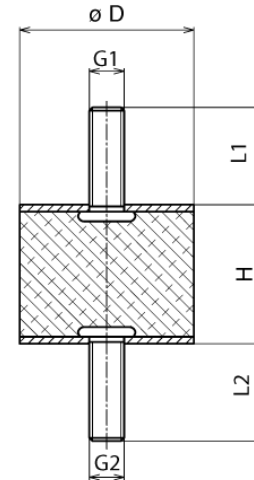

## 8. Torque Threaded Stud Test of elasto-A- and B-Mounts

Tighten flat bar steel on jaw vise. Setup required torque wrench per table. Use a nut for specimen and tighten it with torque wrench until the required torque is achieved. Loosen nut from specimen and visual check threaded studs for:

- Stud extension
- Thread pitch damaged or sheered
- Connection between washer
- Broken stud

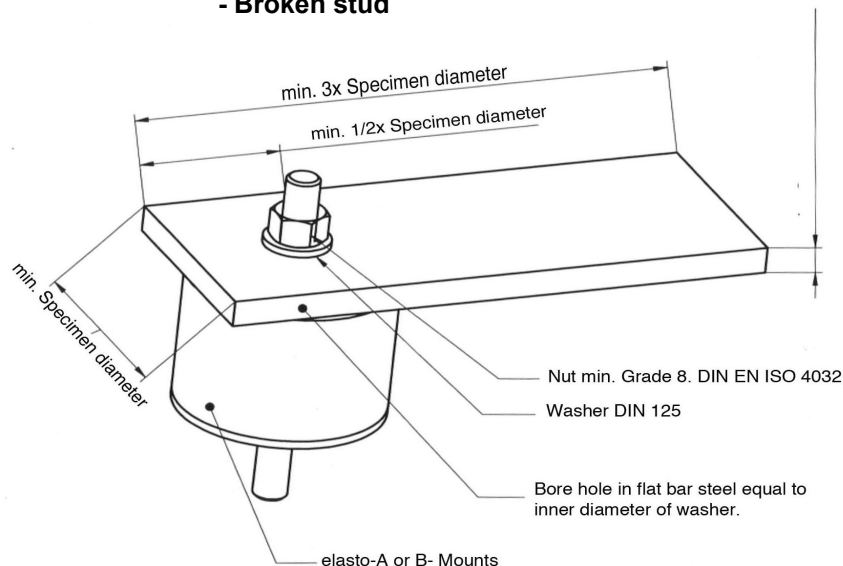





# 3838A10U25

elasto-A-Mounts 38x38  
 38x38 A UNC3/8-16/25 Shore A

Dimensions:

|           |           |
|-----------|-----------|
| D         | H         |
| 1.50      | 1.50      |
| G1        | G2        |
| UNC3/8-16 | UNC3/8-16 |
| L1        | L2        |
| 0.98      | 0.98      |
| Elastomer | ShoreA    |
|           | 57        |

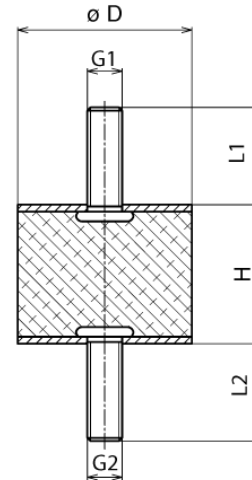

9. Certificate of RoHS Compliance

Customer

We confirm that these mounts are RoHS Compliance.

9. Shelf Life Expectancy

Rubber to metal bonded products have a shelf life expectancy of up to 20 years under certain conditions such as room temperature and avoiding direct sunlight or artificial lights.

**- ALWAYS KEEP PARTS AWAY FROM DIRECT SUNLIGHT AND BETWEEN 10° - 30° CELSIUS -**