

## Applications

- Engines
- CNC Machinery
- Stamping Presses
- Roll Mills
- Motors
- Pumps
- Paper Machine Presses
- Cable Machinery
- Air Compressors
- Generators
- Gearboxes

elasto-Machine-Mounts isolate shock, motion and vibration of heavy production machinery. The horizontal stiffness is larger than the vertical stiffness. The recommended use of elasto-Machine-Mounts is when the requirements are to avoid horizontal movements.

### CHARACTERISTICS AND CAPABILITIES OF ELASTO-MACHINE-MOUNTS

**-Motion Isolation:** Production efficiency is only possible with preventable downtime. elasto-Machine-Mounts will protect sensitive electric motor or aggregates from incurred movements.

**-Vibration Absorption:** Most machinery transfers vibrations to the immediate environment. With the installation of our elasto-Machine-Mounts the vibration transfer will be prevented.

**-Noise Reduction:** All Machinery not isolated produce motion and noise. An effective isolation will be evident with the installation of our elasto-Machine-Mounts

### ELASTO-MACHINE-MOUNTS (ADVANCED DESIGN)

The unique design of the elasto-Machine-Mounts is that the horizontal stiffness is greater than the vertical stiffness, which is necessary for effective isolation issues.

**-Fail-Safe Design:** This important feature is advantageous in some applications with tension force

**-Low overall heights:**

**-High Load Capacity:** Different sizes for most applications. Mounts available are effective up to a 2,400 kg (5,300 LBS) load.

**-Height Adjustment:** This unique feature of leveling prevents vibration transfer to costly machinery, static platforms or factory floors.

**-Maintenance Free** and Long Term Durability:

**-The advanced design** prevents oil and grease accumulation on the rubber surface. This allows for the use of durable natural rubber.

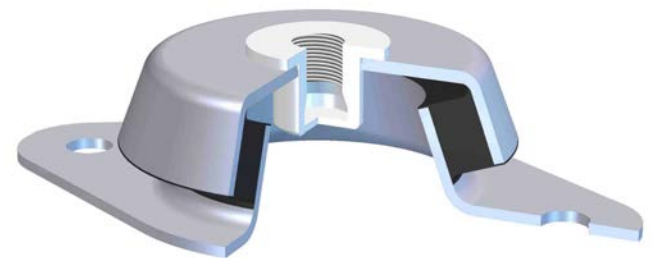
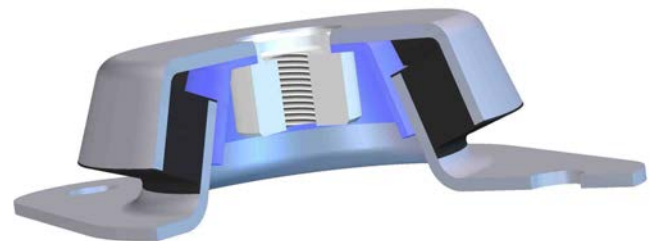
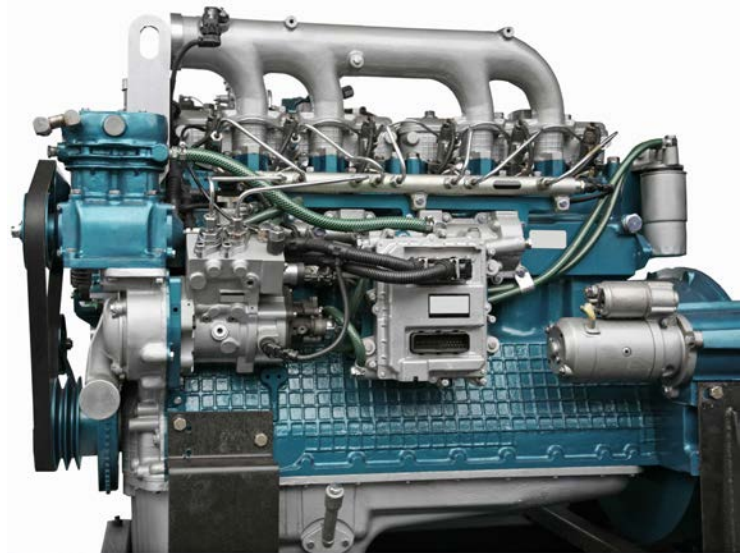

The information herein is general in nature and is not intended for specific application purposes. We suggest that product samples be tested and approved based on your intended application. We reserve the right to alter specifications or withdraw products without prior notice.

## Fail-Safe

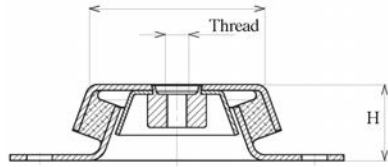

Style 1

## Standard

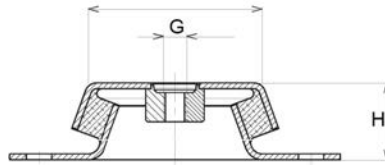

Style 2

## Height-Adjustable

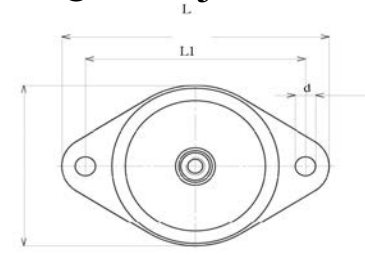

Style 3

## Two-Hole-Flange

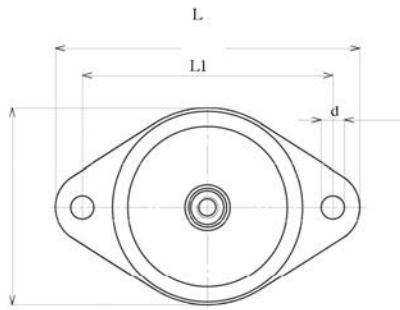

Design 1

## Four-Hole-Square

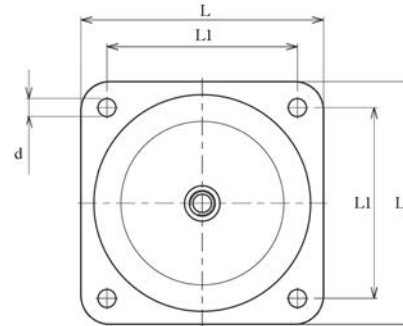

Design 2

Part Number	Length x Height mm (Inch) (L) x (H)	Mounting hole (Inch) (d)	Hole Separation mm (Inch) (L1)	Thread size mm (Inch) (G)	Style	Design	Quality		Max. Static Compression Force (vertical)		Max. Static Shear Force (horizontal)	
							ShoreA Duro	Elasto-	kN	lbs	kN	lbs
MP128A	128 x 30 (5.04) x (1.18)	12.7 (.50)	105 (4.13)	M10	1		43	NR	1.10	247	1.34	302
MP128012				M10	2	1	57		1.80	405	2.20	495
MP128112				M12x1.5	3		68		2.88	647	3.52	791
MP170A	170 x 39 (6.69) x (1.54)	12.7 (.50)	140 (5.51)	M12	1		43	NR	3.36	754	4.27	960
MP170013				M12	2	1	57		5.50	1,236	7.0	1,574
MP170113				M16x1.5	3		68		8.80	1,978	11.20	2,518
MP216A	216 x 52 (8.50) x (2.05)	12x14 (.50x.55)	184 (7.24)	M16	1	1	43	NR	6.41	1,440	7.32	1,646
						57	10.50		2,360	12.0	2,698	
						68	16.80		3,777	19.20	4,316	
MP168A	168 x 52 (6.61) x (2.05)	12.7 (.50)	132 (5.20)	M16	1		43	NR	6.41	1,440	7.32	1,646
MP168011				M16	2	2	57		10.50	2,360	12.0	2,698
MP168111				M20x2	3		68		16.80	3,777	19.20	4,316
MP184A	184 x 63 (7.24) x (2.48)	12.7 (.50)	150 (5.91)	M20	1		43	NR	12.51	2,811	14.34	3,223
MP184010				M20	2	2	57		20.50	4,609	23.50	5,283
MP184110				M20x2	3		68		32.80	7,374	37.60	8,453

The information herein is general in nature and is not intended for specific application purposes. We suggest that product samples be tested and approved based on your intended application. We reserve the right to alter specifications or withdraw products without prior notice.